

DATA SHEET

SE2609L: 2.4 GHz Power Amplifier with Power Detector
Preliminary Information

Applications

- DSSS 2.4 GHz WLAN (IEEE802.11b)
- OFDM 2.4 GHz WLAN (IEEE802.11g or IEEE802.11n)
- Access Points, PCMCIA, PC cards

Features

- 3.3 V Supply Operation with 2.85 V reference
 - 19 dBm, EVM = 3 %, 802.11g, OFDM 54 Mbps
 - 22 dBm, ACPR < -32 dBc, 802.11b
- 5.0V Supply Operation with 2.85V reference
- 28 dB Gain
- Integrated temperature compensated power detector
- Analog reference voltage control for maximum flexibility
- Lead Free, Halogen Free and RoHS compliant
- Small package: 8 pin 2 mm x 2 mm x 0.9 mm QFN, MSL 1

Product Description

The SE2609L is a 2.4 GHz power amplifier designed for use in the 2.4 GHz ISM band for wireless LAN applications. The device incorporates a power detector for closed loop monitoring of the output power.

The SE2609L is enabled by a 2.85V reference.

The SE2609L temperature compensated power detector is highly immune to mismatch at its output with less than 1.5 dB of variation with a 2:1 mismatch.

Ordering Information

Part Number	Package	Remark
SE2609L	8 Pin QFN	Samples
SE2609L-R	8 Pin QFN	Tape and Reel
SE2609L-AK1	Application Kit	Standard

DATA SHEET
SE2609L: 2.4 GHz Power Amplifier with Power Detector
Preliminary Information

Functional Block Diagram

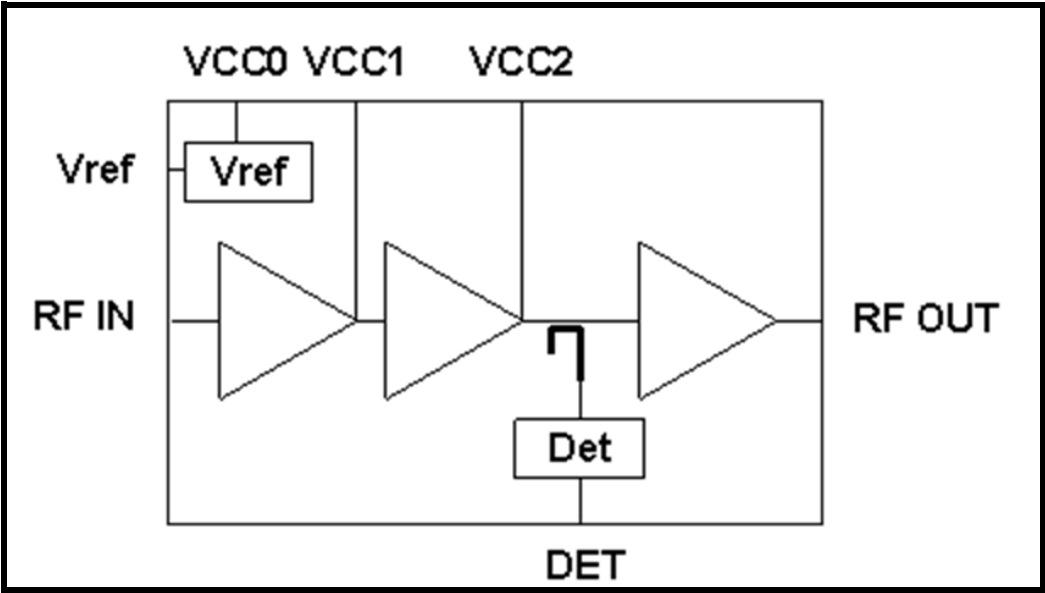

Figure 1: Functional Block Diagram

Pin Out Diagram

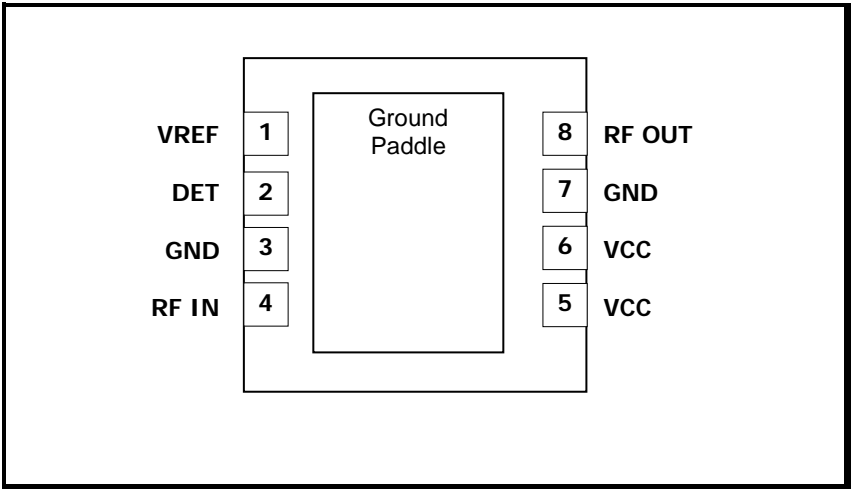

Figure 2: SE2609L Pin-Out Diagram

Pin Out Description

Pin No.	Name	Description
1	VREF	Reference voltage supply

DATA SHEET**SE2609L: 2.4 GHz Power Amplifier with Power Detector
Preliminary Information**

2	DET	Analog power detector output
3	GND	Ground
4	RF_IN	RF input
5	VCC	Supply stage 1 and 0
6	VCC	Supply stage 2
7	GND	Ground
8	RF_OUT	RF output & Supply Stage 3

DATA SHEET
SE2609L: 2.4 GHz Power Amplifier with Power Detector
Preliminary Information

Absolute Maximum Ratings

These are stress ratings only. Exposure to stresses beyond these maximum ratings for a long period of time may cause permanent damage to, or affect the reliability of the device. Avoid operating the device outside the recommended operating conditions defined below. This device is ESD sensitive. Handling and assembly of this device should be at ESD protected workstations.

Symbol	Definition	Min.	Max.	Unit
V _{CC}	Supply Voltage on pins V _{CC}	-0.3	5.5	V
V _{REF}	Power Amplifier Reference Voltage	-0.3	3.6	V
RFin	RF Input Power, RF_OUT terminated into 50Ω match	-	10	dBm
T _{STG}	Storage Temperature Range	-40	150	°C
ESD _{HBM}	JEDEC JESD22-A114 all pins		500	V

Recommended Operating Conditions

Symbol	Parameter	Min.	Max.	Unit
V _{CC}	Supply Voltage	3.0	5.5	V
T _A	Ambient Temperature	-20	85	°C

DC Electrical Characteristics

Conditions: V_{CC} = 3.3, V_{REF} = 2.85 V, T_A = 25 °C, as measured on Skyworks Solutions' SE2609L-EK1 evaluation board, unless otherwise noted.

Symbol	Parameter	Conditions	Min.	Typ.	Max.	Unit
I _{CC-802.11b}	Supply Current (Sum of V _{CC0} , V _{CC} , V _{CC3})	P _{OUT} = 22 dBm, 11 Mbps CCK signal, BT = 0.45, V _{CC} = V _{CC3} = 3.3 V	-	200	-	mA
		P _{OUT} = 24 dBm, 11 Mbps CCK signal, BT = 0.45, V _{CC} = V _{CC3} = 5.0 V		260		
I _{CC-802.11g}	Supply Current (Sum of V _{CC} , V _{CC3})	P _{OUT} = 19 dBm, 54 Mbps OFDM signal, 64 QAM, V _{CC} = V _{CC3} = 3.3 V	-	160	-	mA
		P _{OUT} = 22 dBm, 54 Mbps OFDM signal, 64 QAM, V _{CC} = V _{CC3} = 5.0 V		220		
I _{CQ}	Supply Current (Sum of V _{CC} , V _{CC3})	No RF	-	100	-	mA
I _{OFF}	Supply Current	V _{REF} = 0 V, No RF	-	2	10	μA
V _{REF}	Reference Voltage	-	2.70	2.85	2.90	V
I _{REF}	Input Current Logic High Voltage	-	-	2.0	-	mA

DATA SHEET
SE2609L: 2.4 GHz Power Amplifier with Power Detector
Preliminary Information

AC Electrical Characteristics

802.11b/g AC Electrical Characteristics

Conditions: $V_{CC} = 3.3V$, $V_{REF} = 2.85 V$, $f = 2.45 GHz$, $T_A = 25 ^\circ C$, as measured on Skyworks Solutions' SE2609L-EK1 evaluation board, unless otherwise noted

Symbol	Parameter	Conditions	Min.	Typ.	Max.	Unit
f _{L-U}	Frequency Range	-	2400	-	2500	MHz
P _{OUT}	Output Power	54 Mbps OFDM signal, 64 QAM, 3% EVM	-	19	-	dBm
		54 Mbps OFDM signal, 64 QAM, 3% EVM, VCC = 5.0V		22		
		11 Mbps CCK signal, BT = 0.45		22		
		11 Mbps CCK signal, BT = 0.45, VCC = 5.0V		24		
P _{1dB}	Output 1dB compression point	No modulation	-	25.5	-	dBm
S ₁₁	Input Return Loss		-	-10	-	dB
S ₂₁	Small Signal Gain	P _{IN} = -25 dBm	26	28	32	dB
ΔS ₂₁	Gain Variation over band	P _{IN} = -25 dBm, f _{IN} = 2400 to 2500 MHz	-	0.5	-	dB
ACPR	Adjacent Channel Power Ratio ±11 MHz offsets from carrier ±22 MHz offsets from carrier	11 Mbps CCK signal, BT = 0.45, P _{OUT} = 22 dBm @ VCC = 3.3 V or P _{OUT} = 24 dBm @ VCC = 5.0 V	-	-33	-	dBc
			-	-52	-	
2f	Harmonic, 1MBPS, BPSK	P _{OUT} = 22 dBm @ VCC = 3.3 V or P _{OUT} = 24 dBm @ VCC = 5.0 V	-	-50	-	dBm/MHz
3f			-	-50	-	dBm/MHz
t _r , t _f	Rise and Fall Time	-	-	0.5	-	μSec
STAB	Stability	P _{OUT} = 22 dBm, 54 Mbps OFDM signal, 64 QAM VSWR = 6:1 All Phases	All non-harmonically related outputs less than -50 dBc/100 kHz			
		P _{OUT} = 24 dBm, 54 Mbps OFDM signal, 64 QAM VSWR = 6:1 All Phases, VCC = 5.0 V				
VSWR	Tolerance to output load mismatching	P _{IN} = 10 dBm, CW, VCC = 3.3 V VSWR = 10:1 All Phases	No damage			
		P _{IN} = -5 dBm, CW, VCC = 5.0V VSWR = 10:1 All Phases				

DATA SHEET
SE2609L: 2.4 GHz Power Amplifier with Power Detector
Preliminary Information

Power Detector

Conditions: $V_{CC} = 3.3$, $V_{REF} = 2.85$ V, $f = 2.45$ GHz, $T_A = 25$ °C, as measured on Skyworks Solutions' SE2609L-EK1 evaluation board, unless otherwise noted

Symbol	Parameter	Conditions	Min.	Typ.	Max.	Unit
PDR	P_{OUT} detect range	-	0	-	P_{1dB}	dBm
VDET	Detector Voltage	$P_{OUT} = 24$ dBm, $V_{CC} = 5.0$ V	-	1.05	-	V
		$P_{OUT} = 22$ dBm, $V_{CC} = 5.0$ V	-	0.90	-	V
		$P_{OUT} = 22$ dBm, $V_{CC} = 3.3$ V	-	0.95	-	V
		$P_{OUT} = 19$ dBm, $V_{CC} = 3.3$ V	-	0.75	-	V
		$P_{OUT} = NO$ RF	-	0.33	-	V
PDZ _{OUT}	Output Impedance	-	-	2.3	-	k Ω
PDZ _{LOAD}	DC load impedance	-	10	-	-	k Ω

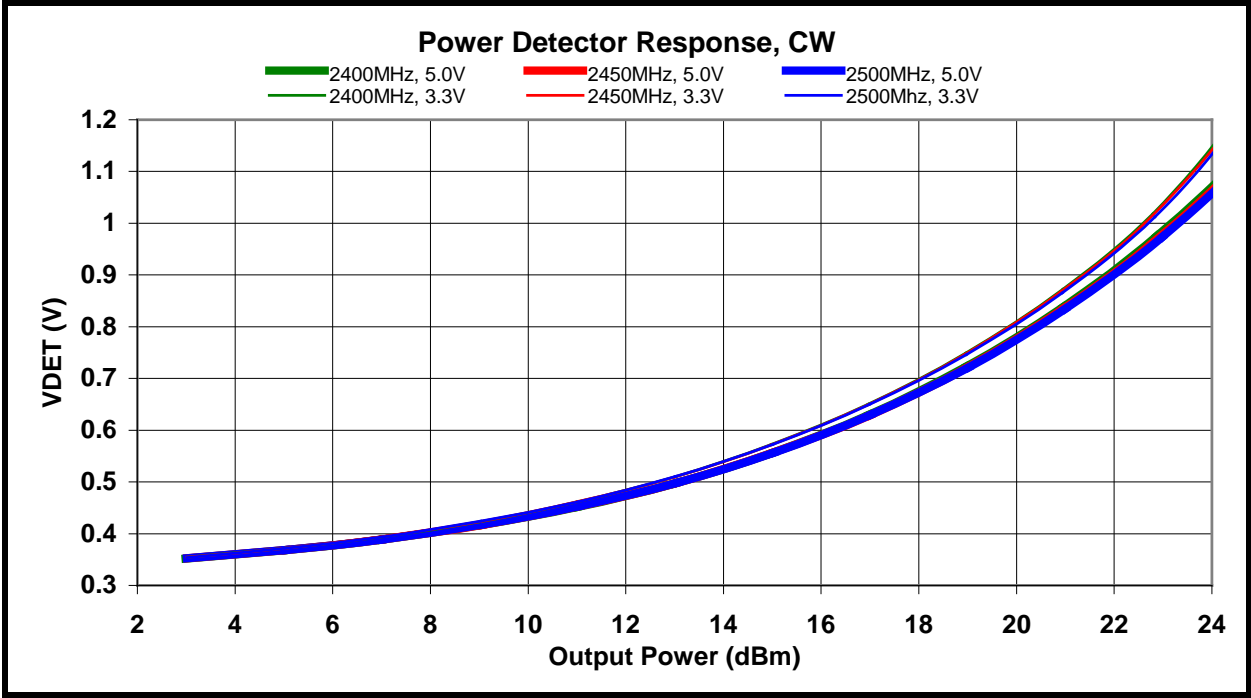

Figure 3: SE2609L Power Detector Characteristic

DATA SHEET
SE2609L: 2.4 GHz Power Amplifier with Power Detector
Preliminary Information

Package Diagram

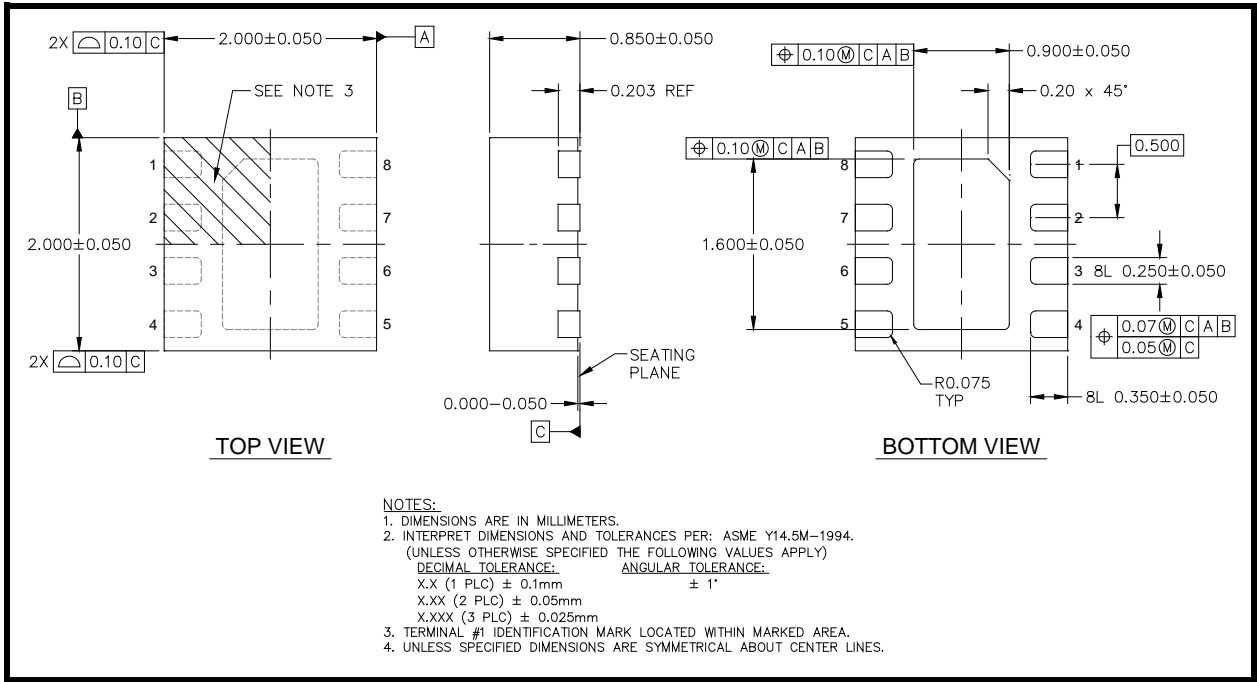

Figure 4: SE2609L Package Diagram

Recommended Land Pattern

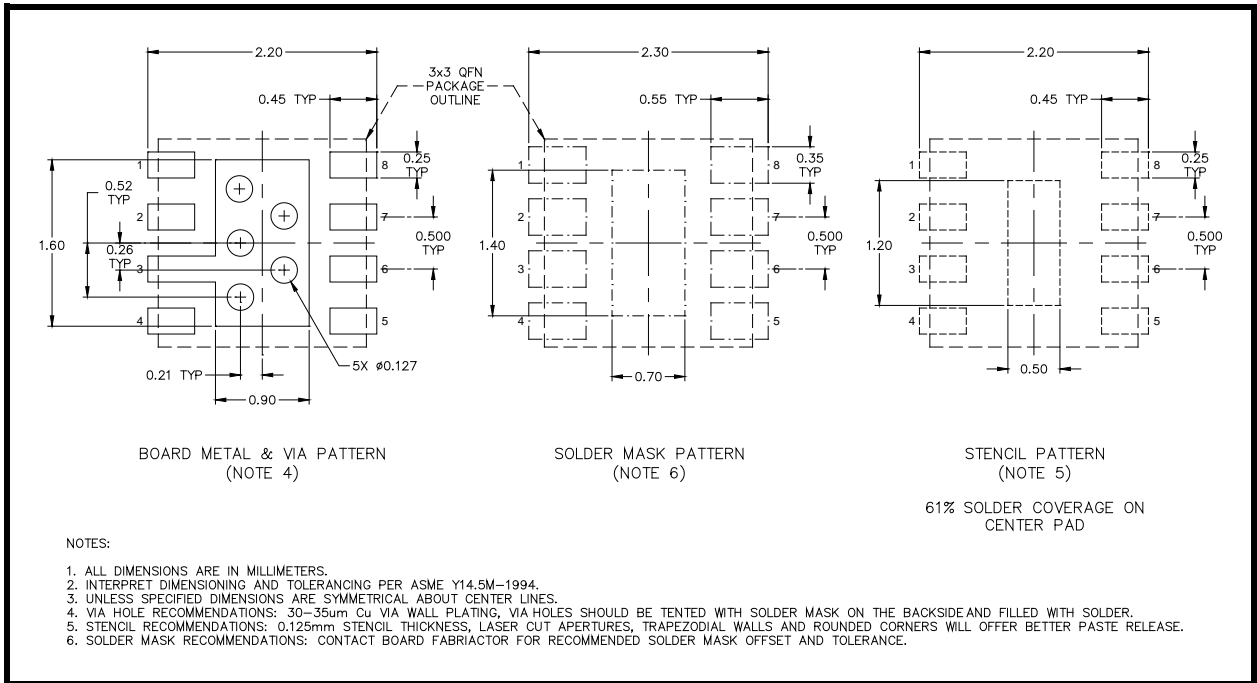

Figure 5: SE2609L Package Diagram

DATA SHEET
SE2609L: 2.4 GHz Power Amplifier with Power Detector
Preliminary Information

Branding Information

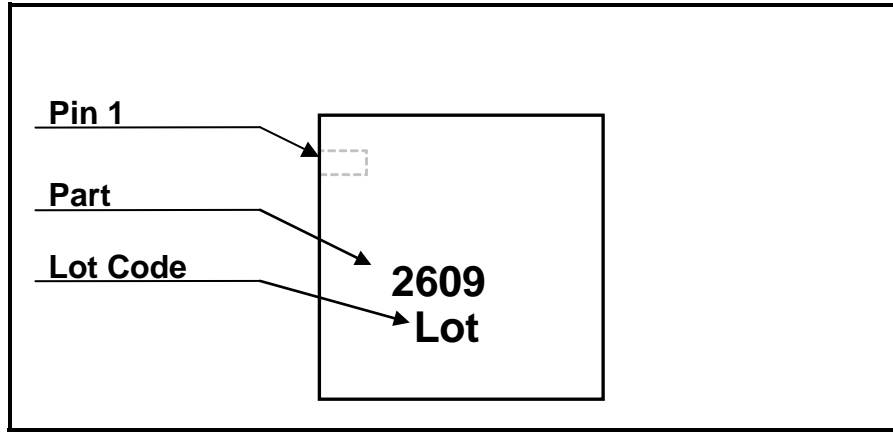

Figure 6: SE2609L Branding and Pin 1 Location (Top View)

Package Handling Information

Because of its sensitivity to moisture absorption, the shipping container must be kept sealed and regarding exposure to moisture after the container seal is broken, otherwise, problems related to moisture absorption may occur when the part is subjected to high temperature during solder assembly. The SE2609L is capable of withstanding a Pb free solder reflow. Care must be taken when attaching this product, whether it is done manually or in a production solder reflow environment. If the part is manually attached, precaution should be taken to insure that the device is not subjected to temperatures above its rated peak temperature for an extended period of time. For details on both attachment techniques, precautions, and handling procedures recommended, please refer to:

- “QFN solder reflow and rework information application note”, Document Number QAD-00045
- “Handling, packing, shipping and use of moisture sensitive QFN application note”, Document Number QAD-00044



Caution! Class 1B ESD sensitive device

DATA SHEET
SE2609L: 2.4 GHz Power Amplifier with Power Detector
Preliminary Information

Tape and Reel Information

Parameter	Value
Devices Per Reel	3000
Reel Diameter	7 inches
Tape Width	8 millimeters

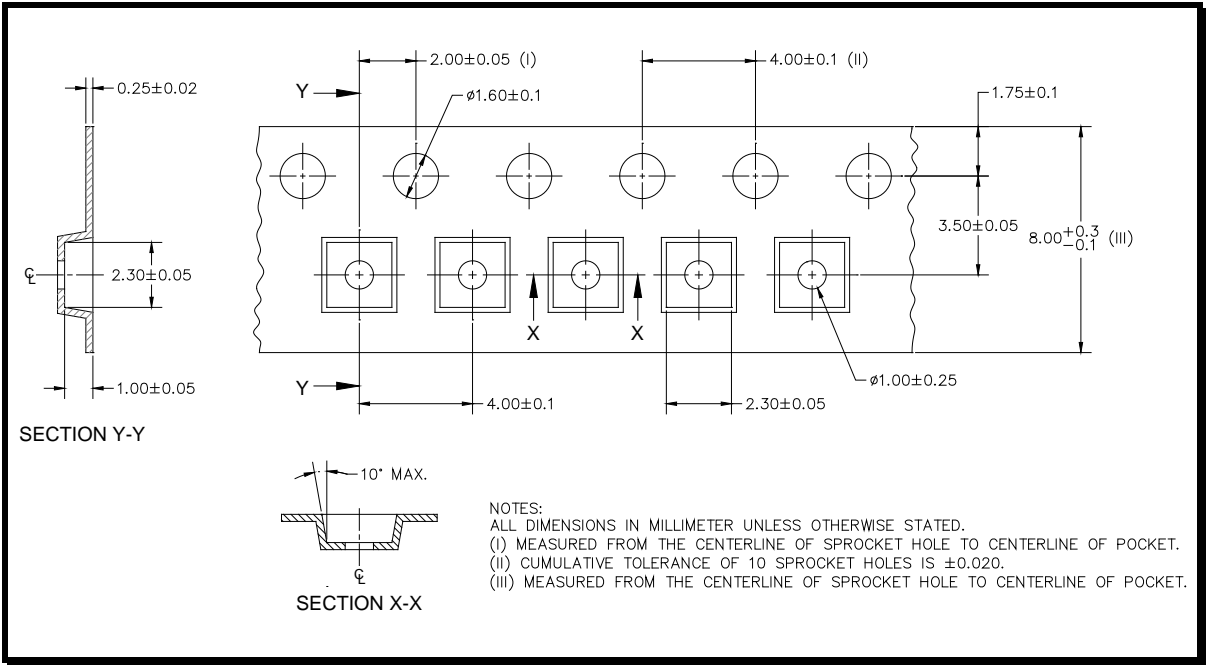

Figure 8: SE2609L-R Tape and Reel Information



DATA SHEET
SE2609L: 2.4 GHz Power Amplifier with Power Detector
Preliminary Information

Document Change History

Revision	Date	Notes
1.0	Mar 23, 2010	Created
1.1	Apr 30, 2010	Updated Package Marking
1.2	Jun 10, 2010	Updated tape and reel information
1.3	Aug 19, 2010	Updated tape and reel information Updated VSWR Conditions
1.4	Oct 12, 2010	Updated to include 5V operating conditions Updated V_{REF} (MIN) to 2.7V
1.5	Nov 01, 2010	Updated ESD rating
1.6	Apr 03, 2012	Updated with Skyworks logo and disclaimer statement

Copyright © 2012 Skyworks Solutions, Inc. All Rights Reserved.

Information in this document is provided in connection with Skyworks Solutions, Inc. ("Skyworks") products or services. These materials, including the information contained herein, are provided by Skyworks as a service to its customers and may be used for informational purposes only by the customer. Skyworks assumes no responsibility for errors or omissions in these materials or the information contained herein. Skyworks may change its documentation, products, services, specifications or product descriptions at any time, without notice. Skyworks makes no commitment to update the materials or information and shall have no responsibility whatsoever for conflicts, incompatibilities, or other difficulties arising from any future changes.

No license, whether express, implied, by estoppel or otherwise, is granted to any intellectual property rights by this document. Skyworks assumes no liability for any materials, products or information provided hereunder, including the sale, distribution, reproduction or use of Skyworks products, information or materials, except as may be provided in Skyworks Terms and Conditions of Sale.

THE MATERIALS, PRODUCTS AND INFORMATION ARE PROVIDED "AS IS" WITHOUT WARRANTY OF ANY KIND, WHETHER EXPRESS, IMPLIED, STATUTORY, OR OTHERWISE, INCLUDING FITNESS FOR A PARTICULAR PURPOSE OR USE, MERCHANTABILITY, PERFORMANCE, QUALITY OR NON-INFRINGEMENT OF ANY INTELLECTUAL PROPERTY RIGHT; ALL SUCH WARRANTIES ARE HEREBY EXPRESSLY DISCLAIMED. SKYWORKS DOES NOT WARRANT THE ACCURACY OR COMPLETENESS OF THE INFORMATION, TEXT, GRAPHICS OR OTHER ITEMS CONTAINED WITHIN THESE MATERIALS. SKYWORKS SHALL NOT BE LIABLE FOR ANY DAMAGES, INCLUDING BUT NOT LIMITED TO ANY SPECIAL, INDIRECT, INCIDENTAL, STATUTORY, OR CONSEQUENTIAL DAMAGES, INCLUDING WITHOUT LIMITATION, LOST REVENUES OR LOST PROFITS THAT MAY RESULT FROM THE USE OF THE MATERIALS OR INFORMATION, WHETHER OR NOT THE RECIPIENT OF MATERIALS HAS BEEN ADVISED OF THE POSSIBILITY OF SUCH DAMAGE.

Skyworks products are not intended for use in medical, lifesaving or life-sustaining applications, or other equipment in which the failure of the Skyworks products could lead to personal injury, death, physical or environmental damage. Skyworks customers using or selling Skyworks products for use in such applications do so at their own risk and agree to fully indemnify Skyworks for any damages resulting from such improper use or sale.

Customers are responsible for their products and applications using Skyworks products, which may deviate from published specifications as a result of design defects, errors, or operation of products outside of published parameters or design specifications. Customers should include design and operating safeguards to minimize these and other risks. Skyworks assumes no liability for applications assistance, customer product design, or damage to any equipment resulting from the use of Skyworks products outside of stated published specifications or parameters.

Skyworks, the Skyworks symbol, and "Breakthrough Simplicity" are trademarks or registered trademarks of Skyworks Solutions, Inc., in the United States and other countries. Third-party brands and names are for identification purposes only, and are the property of their respective owners. Additional information, including relevant terms and conditions, posted at www.skyworksinc.com, are incorporated by reference.